

1 Top  
Scale: 3/8" = 1'-0"

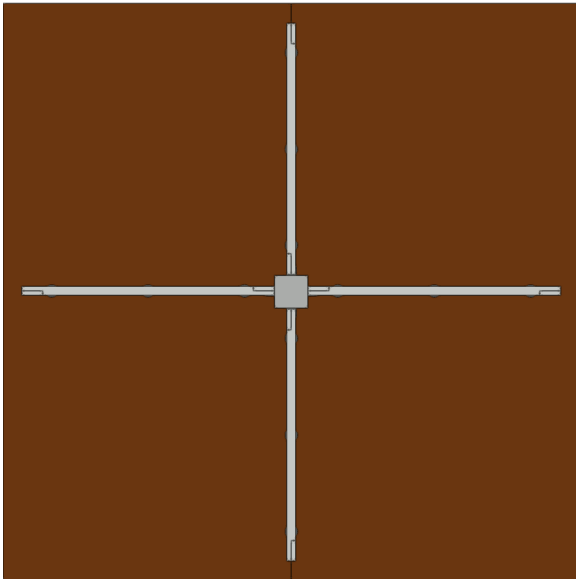

2 Front  
Scale: 3/8" = 1'-0"

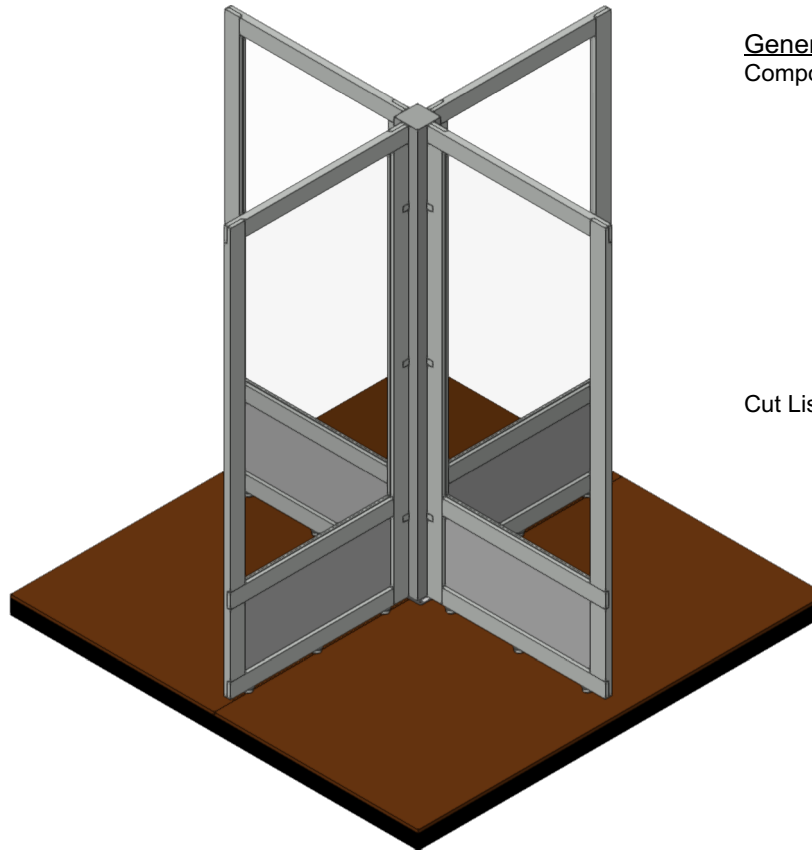
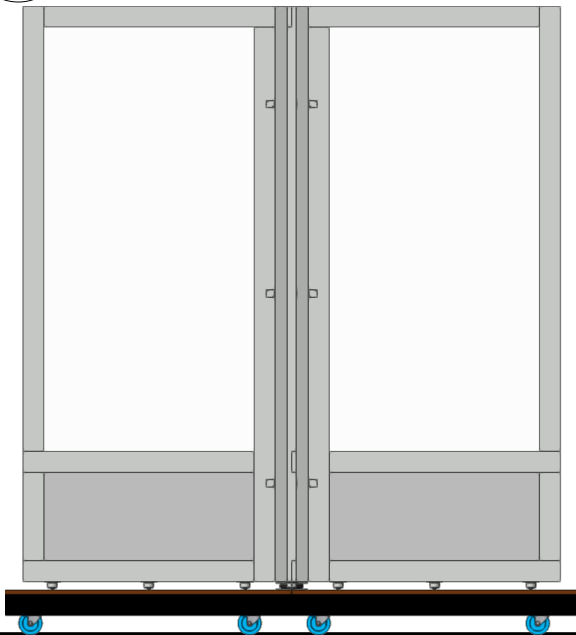

3 Iso  
Scale: 3/8" = 1'-0"

**General Notes**

- Components. (2) 4x8 Platforms with Blocks and Casters  
 \*\*Platforms are not included in the cut list please see Platform Drawing\*\*
- (4) Plexiglass Lap Doors with Ball Bearing Rollers
- (1) Center Post on Heavy Duty Swivel

- Cut List:
- 1/8" Acrylic Sheet:  
 (4) 3'-0"x6'-0"
- Luan:  
 (4) 3'-0"x1'-4"
- 6x6 Lumber:  
 (1) 8'-0"
- 2x4 Lumber:  
 (8) 8'-0" with Laps & Mortise  
 (12) 3'-6" with Laps & Mortise  
 \*\*See Lap & Mortise Page\*\*

Show Name Catch Me If YouCan		
Scale 3/8"=1'	Drawn By Scott Bedell	Date 3/25/2019
Scene: Rotating Door	Object Overview	Page Number 1

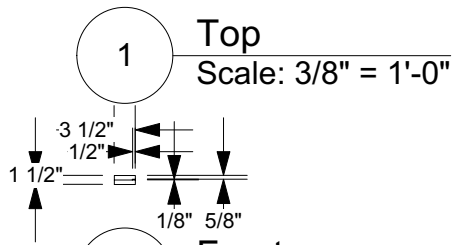

1 Top  
Scale: 3/8" = 1'-0"

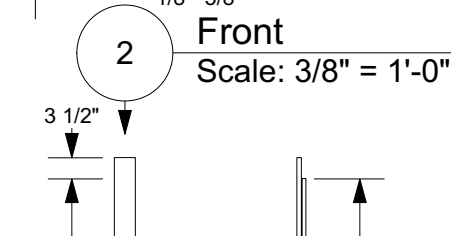

2 Front  
Scale: 3/8" = 1'-0"

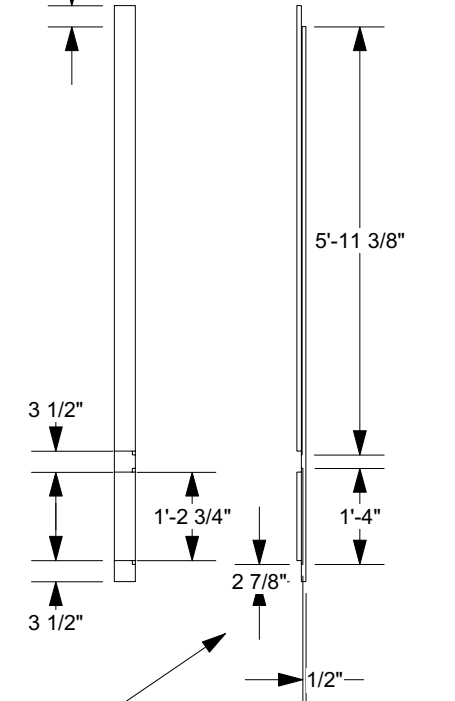

3 Side  
Scale: 3/8" = 1'-0"

General Notes  
Note:.. Cut (8)

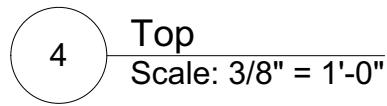

4 Top  
Scale: 3/8" = 1'-0"

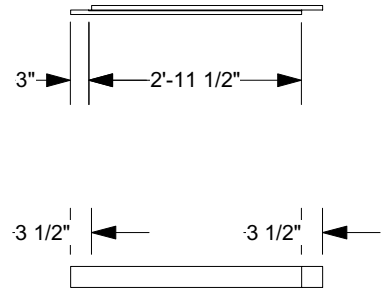

5 Front  
Scale: 3/8" = 1'-0"

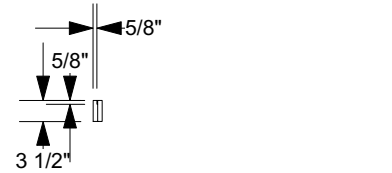

6 Side  
Scale: 3/8" = 1'-0"

General Notes  
Note:.. Cut (8)

General Notes  
Notes:.. -Make all lap dado cuts to fit nominal 2x4  
  
-Make all mortise grooves to fit acrylic sheet or luan snug.

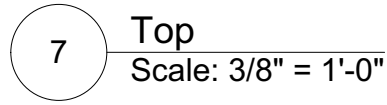

7 Top  
Scale: 3/8" = 1'-0"

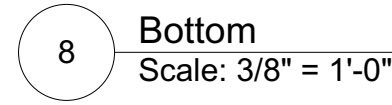

8 Bottom  
Scale: 3/8" = 1'-0"

General Notes  
Note:.. Cut (4)

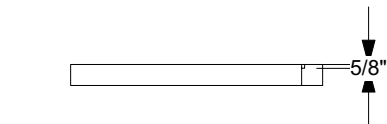

9 Front  
Scale: 3/8" = 1'-0"



10 Side  
Scale: 3/8" = 1'-0"

Show Name Catch Me If YouCan		
Scale 3/8"=1'	Drawn By Scott Bedell	Date 3/25/2019
Scene: Rotating Door-2	Object Lap & Mortise	Page Number 2

1 Top  
Scale: 3/8" = 1'-0"

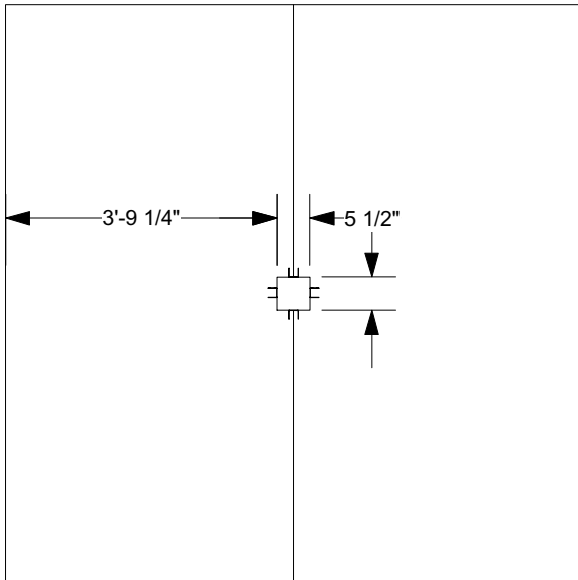

2 Front  
Scale: 3/8" = 1'-0"

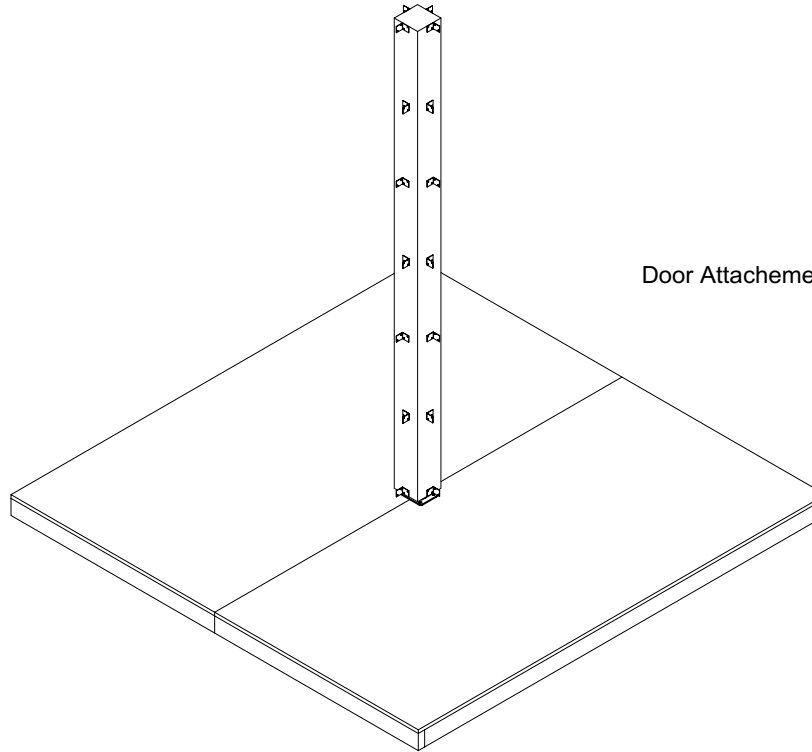
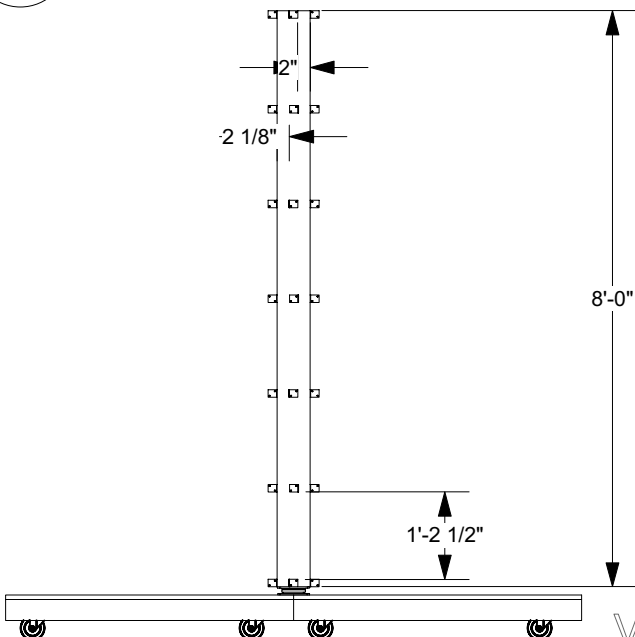

3 Iso  
Scale: 3/8" = 1'-0"

**General Notes**

-The angle mending plates should be 1-1/2" wide by 1-1/4" high. If they are not this size, please adjust spacing accordingly.

-Angle Mending Plate Spacing = 1'-2-1/2" with a piece at the top and bottom of the center rod.

-Angle Mending Plates should alternate directions. Please check that these will fit the nominal 2x4 sideways. Drawings were based on 1-1/2" exact fit.

Door Attachment.-Attach doors at angle mending points with M8 bolts rather than screws to ensure exact fit and remounting.

Show Name Catch Me If YouCan		
Scale 3/8"=1'	Drawn By Scott Bedell	Date 3/25/2019
Scene: Rotating Door-3	Object Center Post	Page Number 3